

777
B1-01 PCM(F)



图 7-1-4 发动机电路图④

[JATX <) L3
 {} 带巡航系统
 % 三重压力开关型



777
 B1-01 PCM(F)

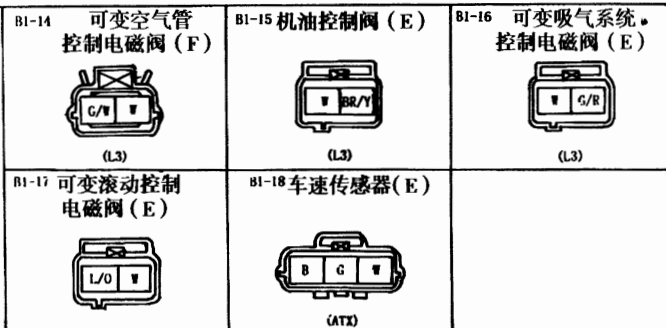
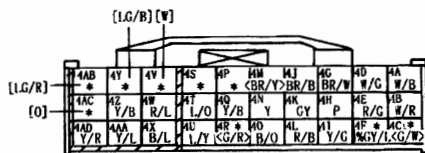
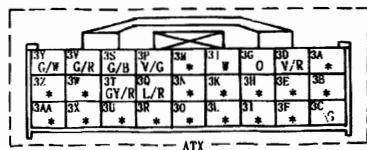
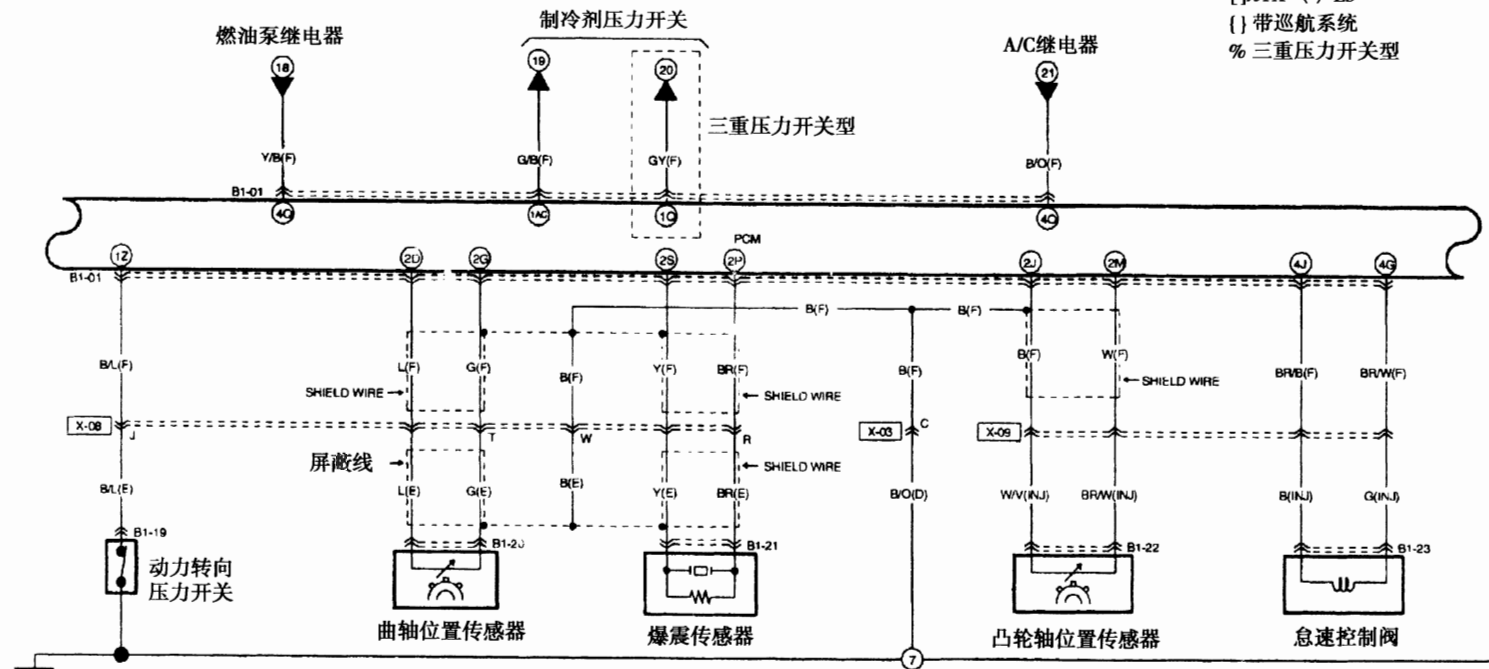

图 7-1-5 发动机电路图⑤



777

B1-01 PCM(F)

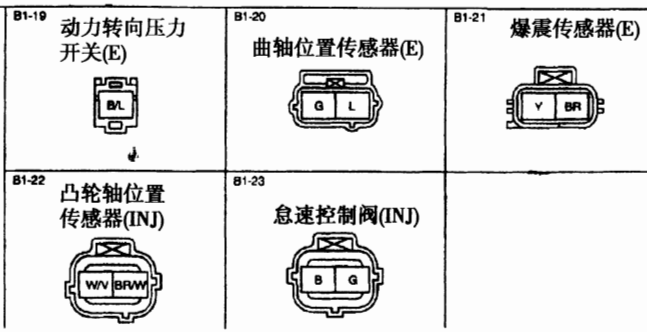
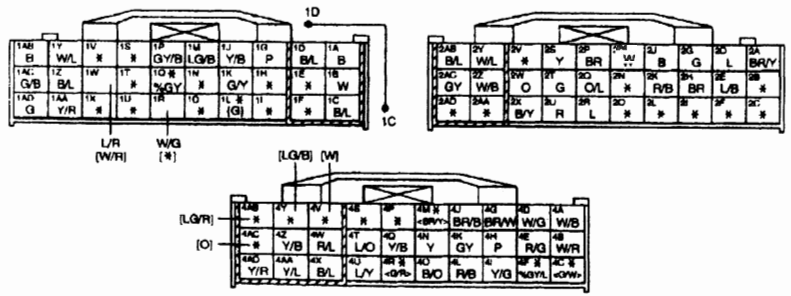
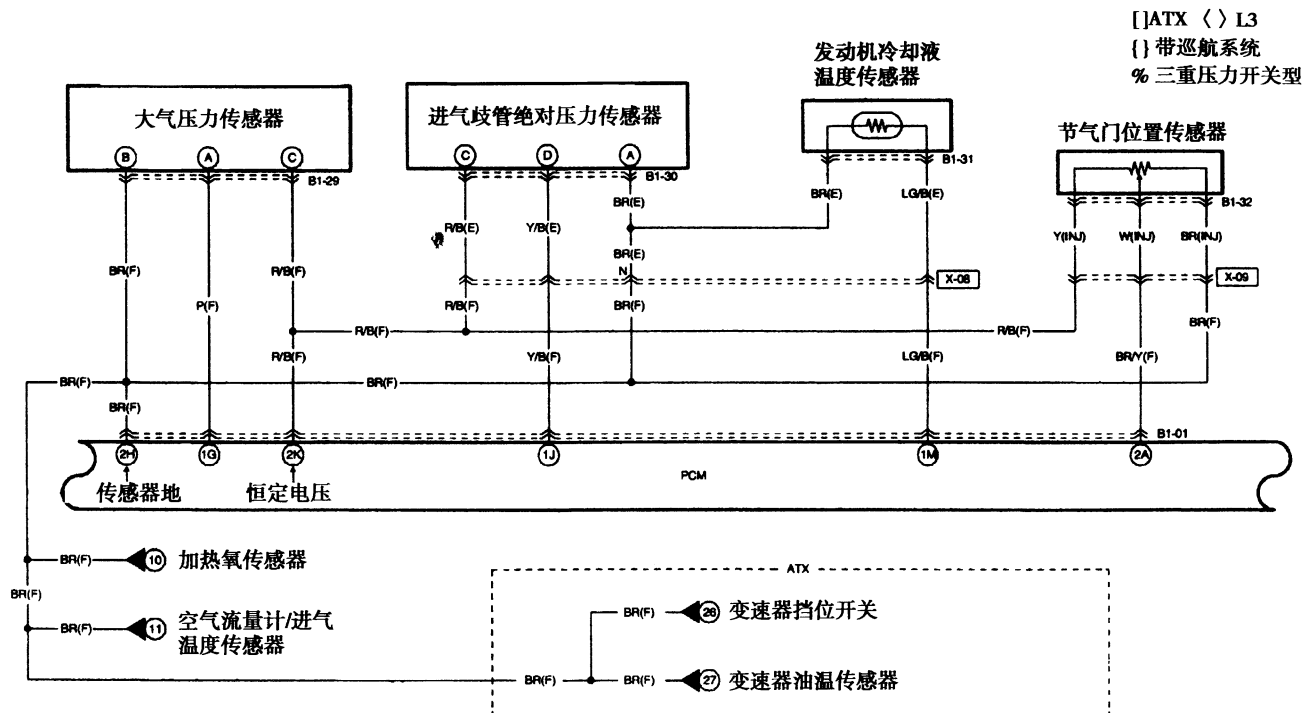
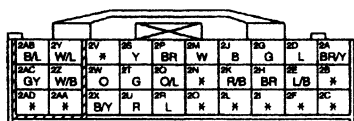
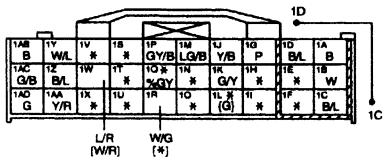

B1-29

大气压力传感器(F)

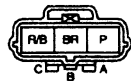

B1-31

发动机冷却液温度传感器(E)



B1-30

进气歧管绝对压力传感器(E)

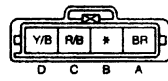

B1-32

节气门位置传感器(INJ)



图 7-1-6 发动机电路图⑥



图 7-1-7 发动机电路图⑦

第二节 底盘电路图

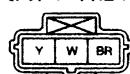
1. 自动变速器电路图见图 7-2-1 ~ 图 7-2-2。
2. 防抱死制动系统 (ABS) / 牵引力控制系统 (TCS) 电路图见图 7-2-3、图 7-2-4。
3. DSC 系统电路图见图 7-2-5、图 7-2-6。
4. A/C 压缩机控制电路图见图 7-2-7。

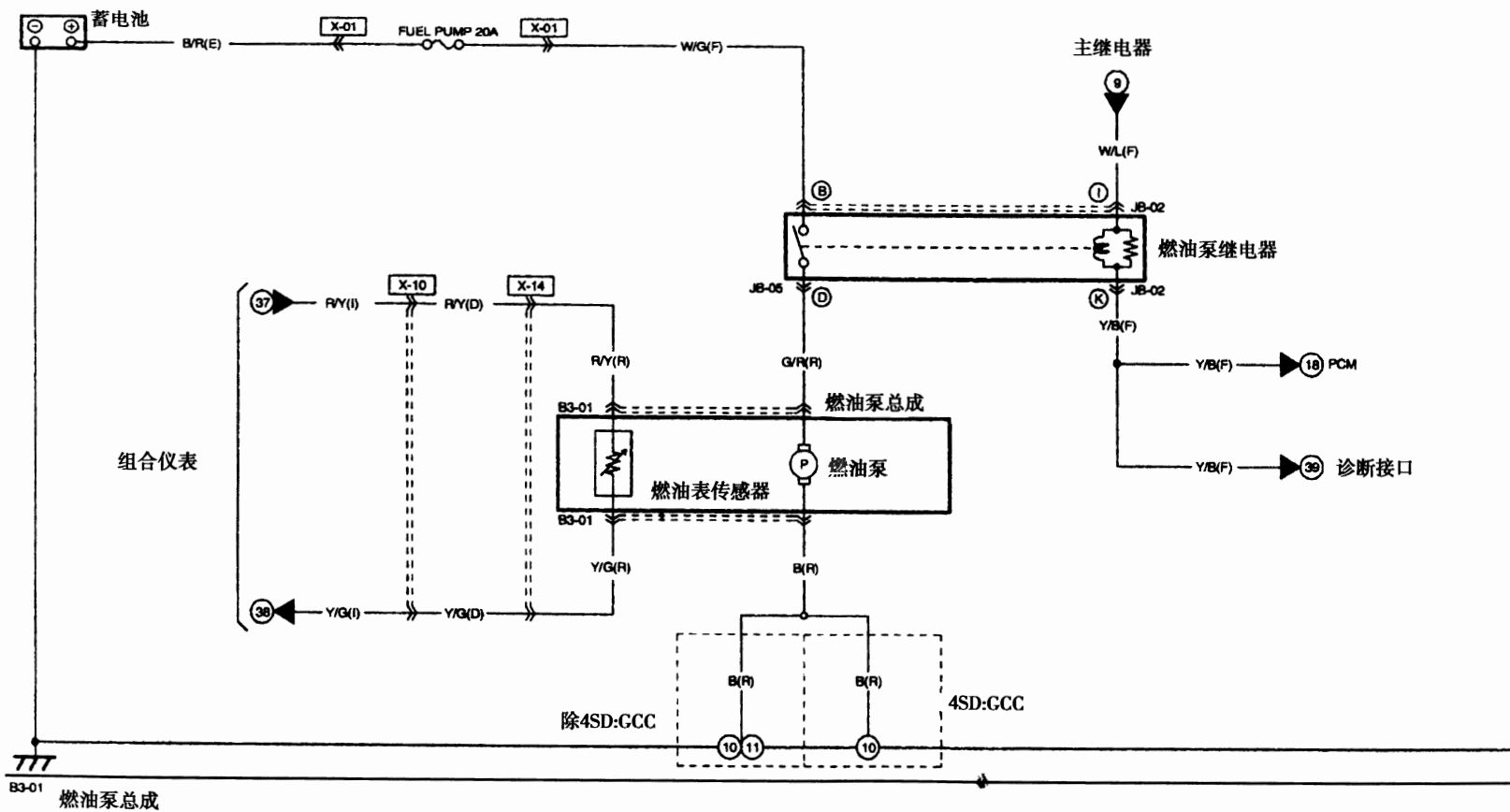

图 7-2-1 自动变速器电路图①



图 7-2-2 自动变速器电路图②

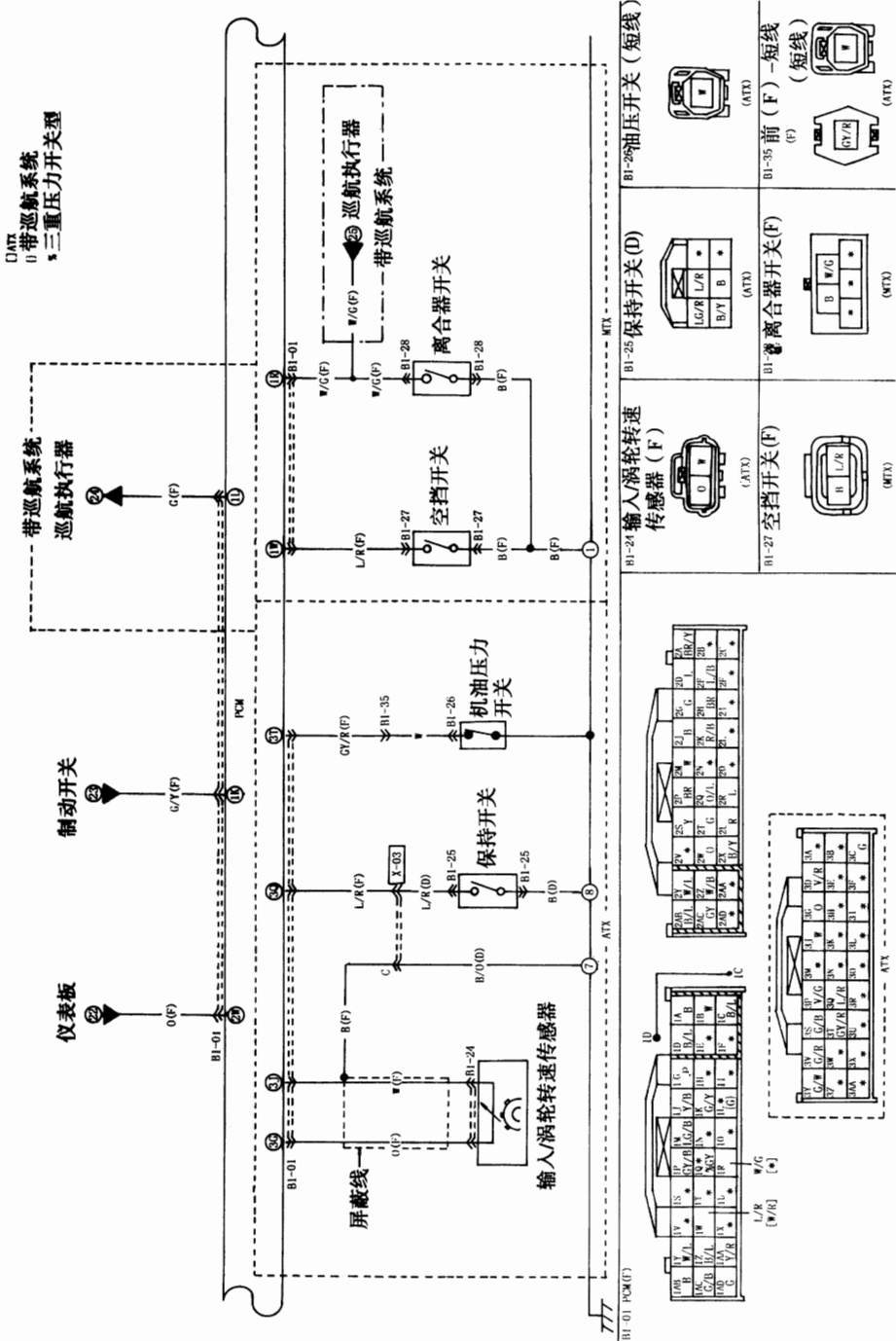

图 7—2—3 防抱死制动系统 (ABS)/牵引力控制系统 (TCS) 电路图①

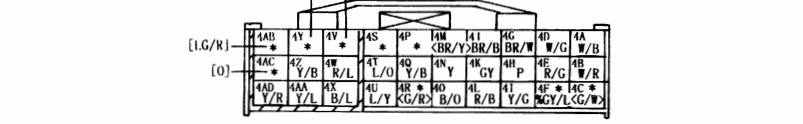
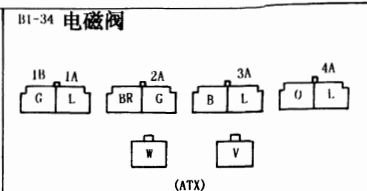
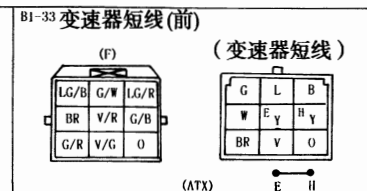
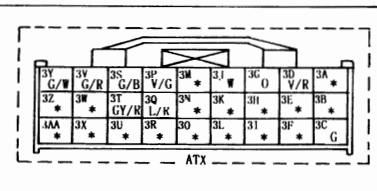
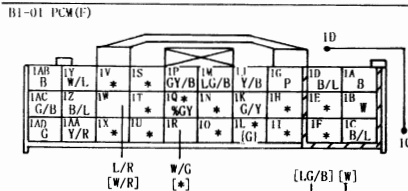
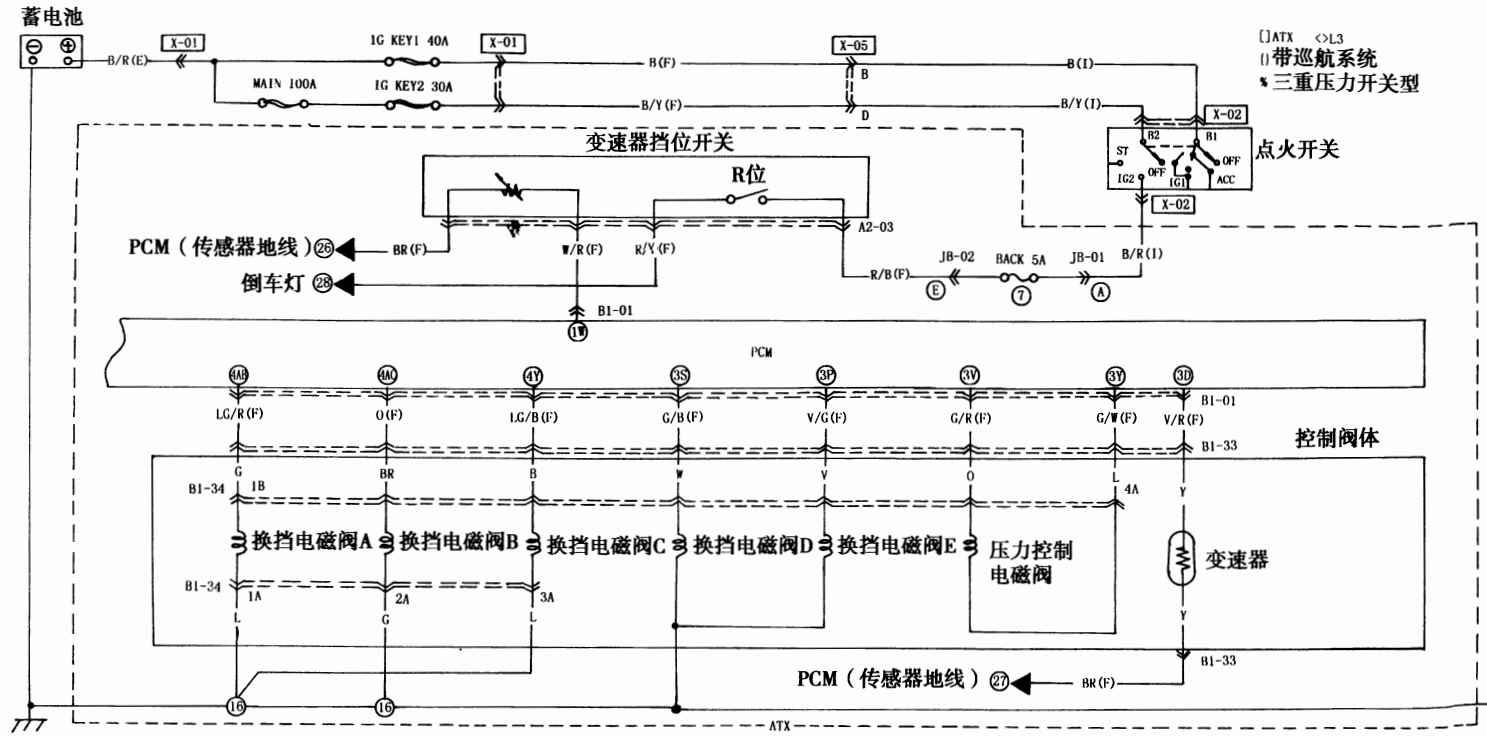

图 7—2—4 防抱死制动系统 (ABS) / 牵引力控制系统 (TCS) 电路图②

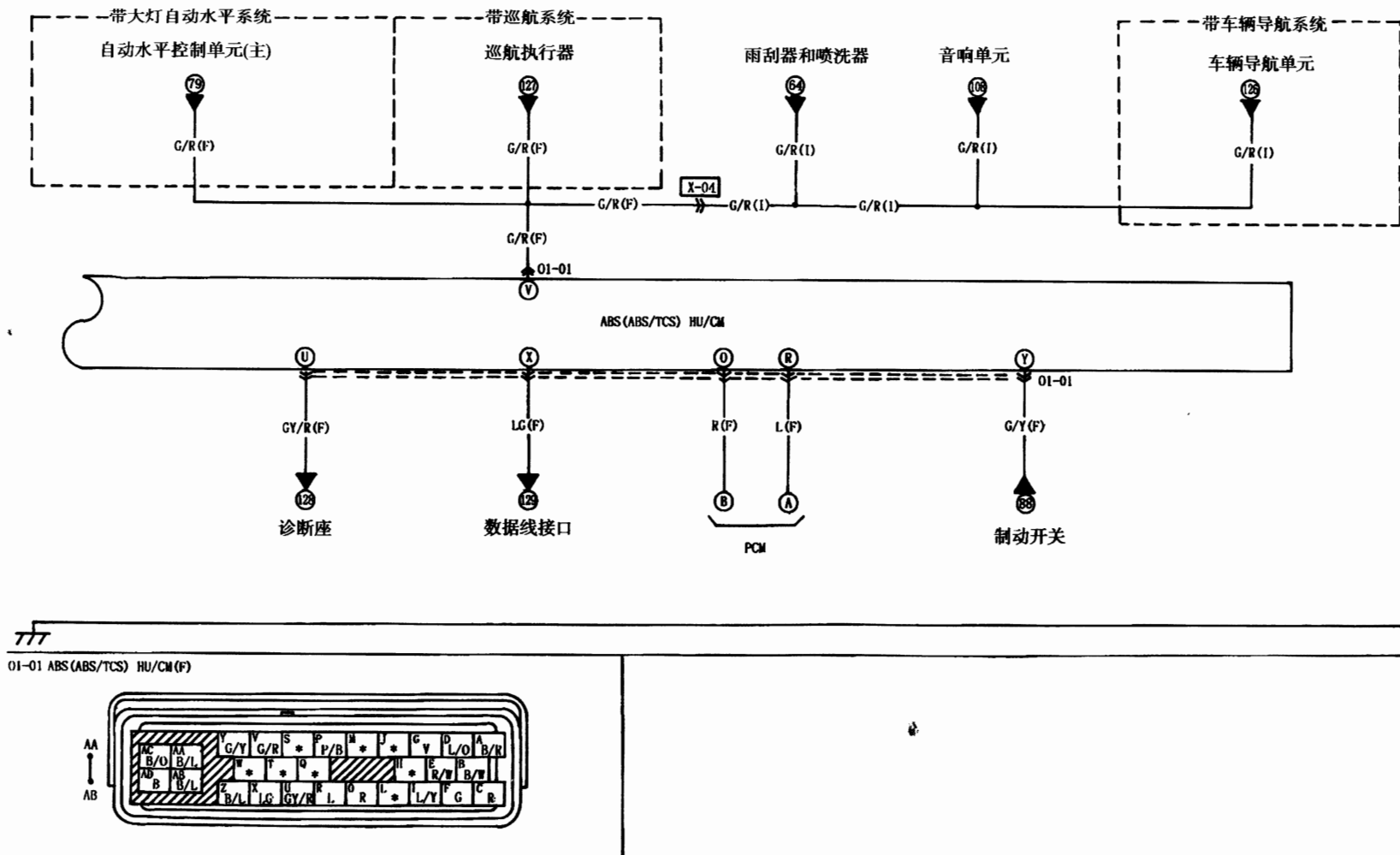

图 7-2-5 DSC 系统电路图①

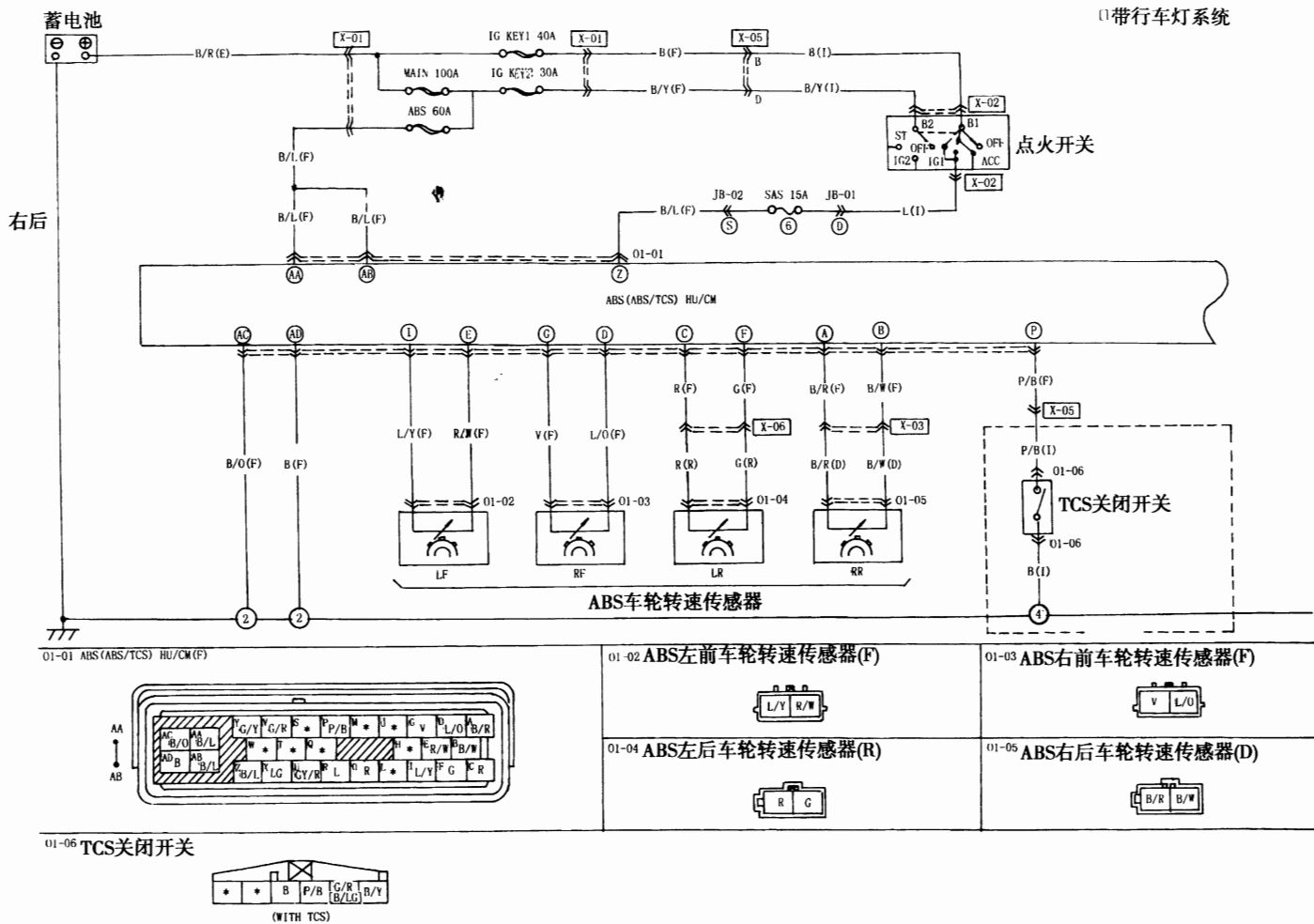

02-01 DSC HU/CM (F)

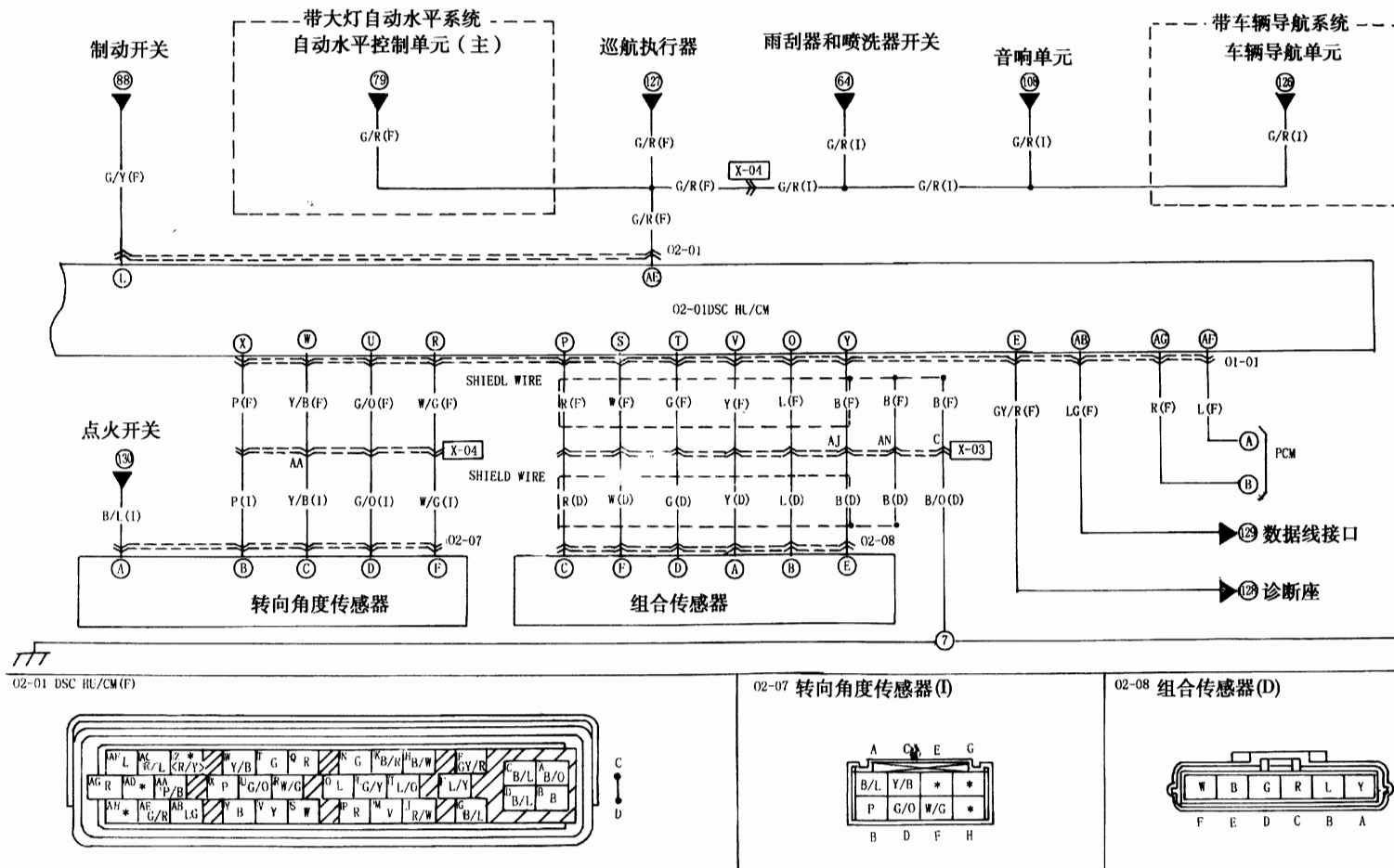
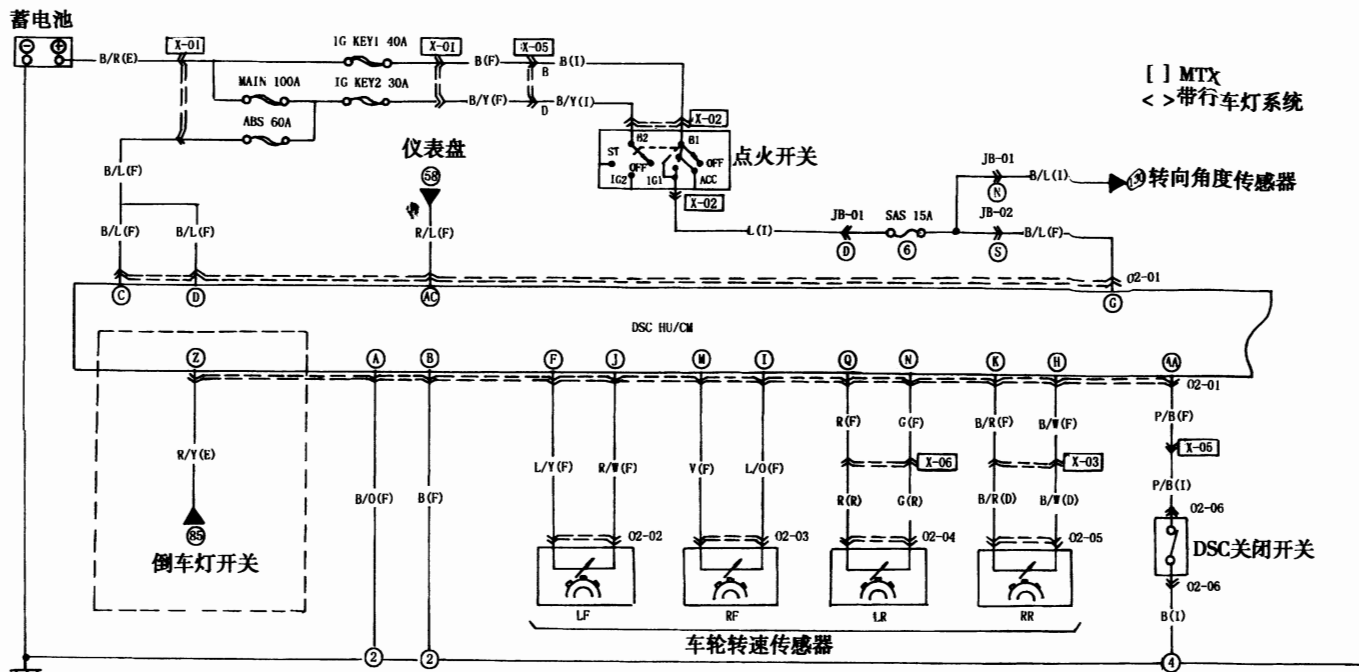
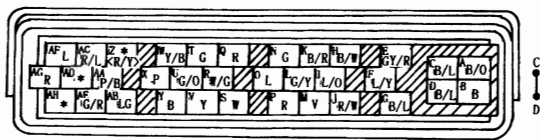

02-06 DSC 关闭开关



图 7-2-6 DSC 系统电路图②



图 7-2-7 A/C 压缩机控制电路图

第三节 电气系统电路图

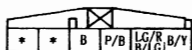
1. 自动空调系统电路图见图 7-3-1~图 7-3-3。
2. 安全气囊系统电路图见图 7-3-4~图 7-3-7。
3. 防盗系统电路图见图 7-3-8。
4. 巡航系统电路图见图 7-3-9。
5. 天窗电路图见图 7-3-10。

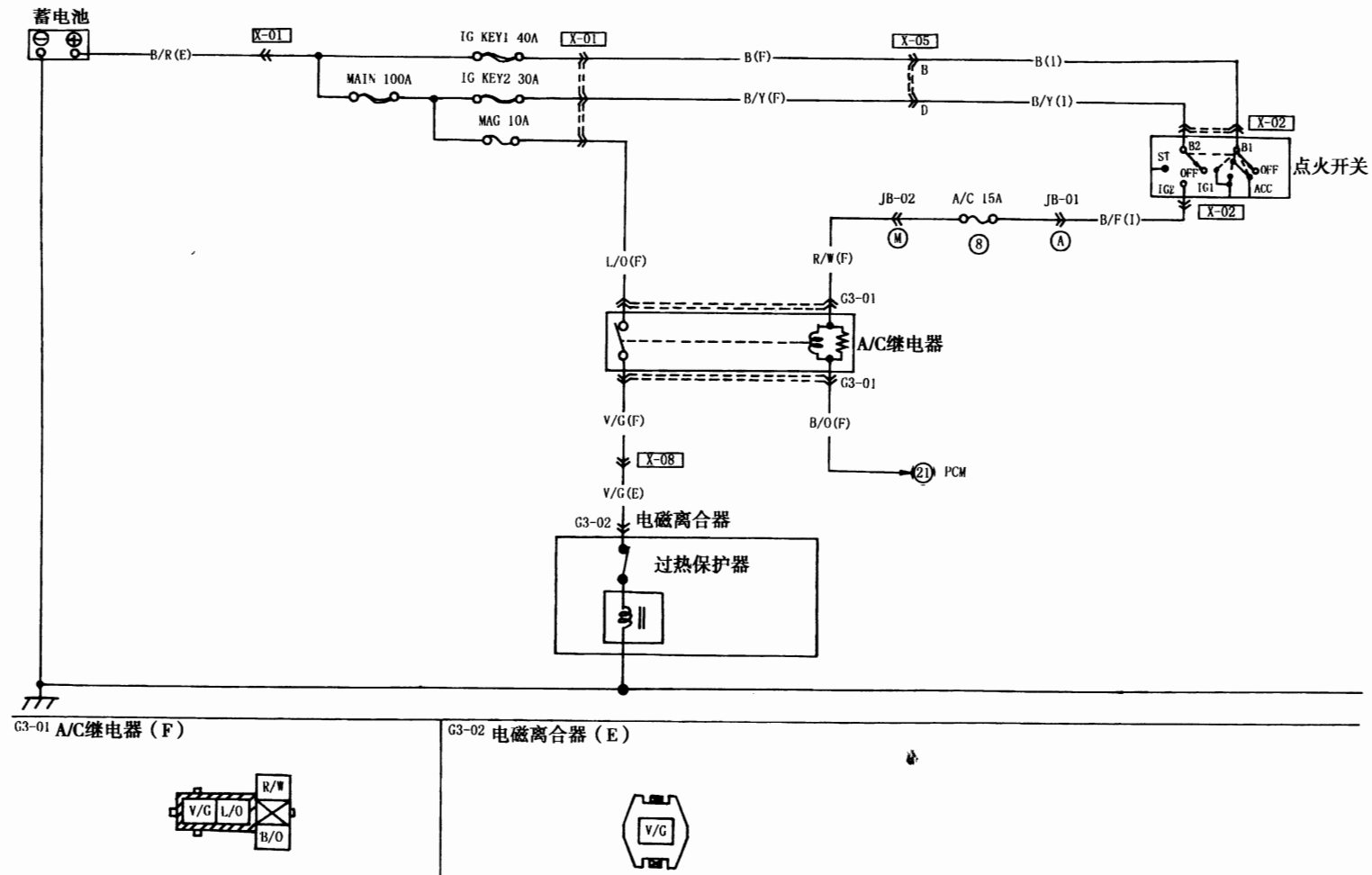

图 7-3-1 自动空调系统电路图①



G2-01 气机电控单元 (I)

W/R	W/L	LG/R	L/B	G/W	Y/B	BR/Y	Y/G	*	V/R	L/R	L/W
L/O	*	B	*	CY/B	*	(B/R)	(B/L)	*	V/Y	*	Y

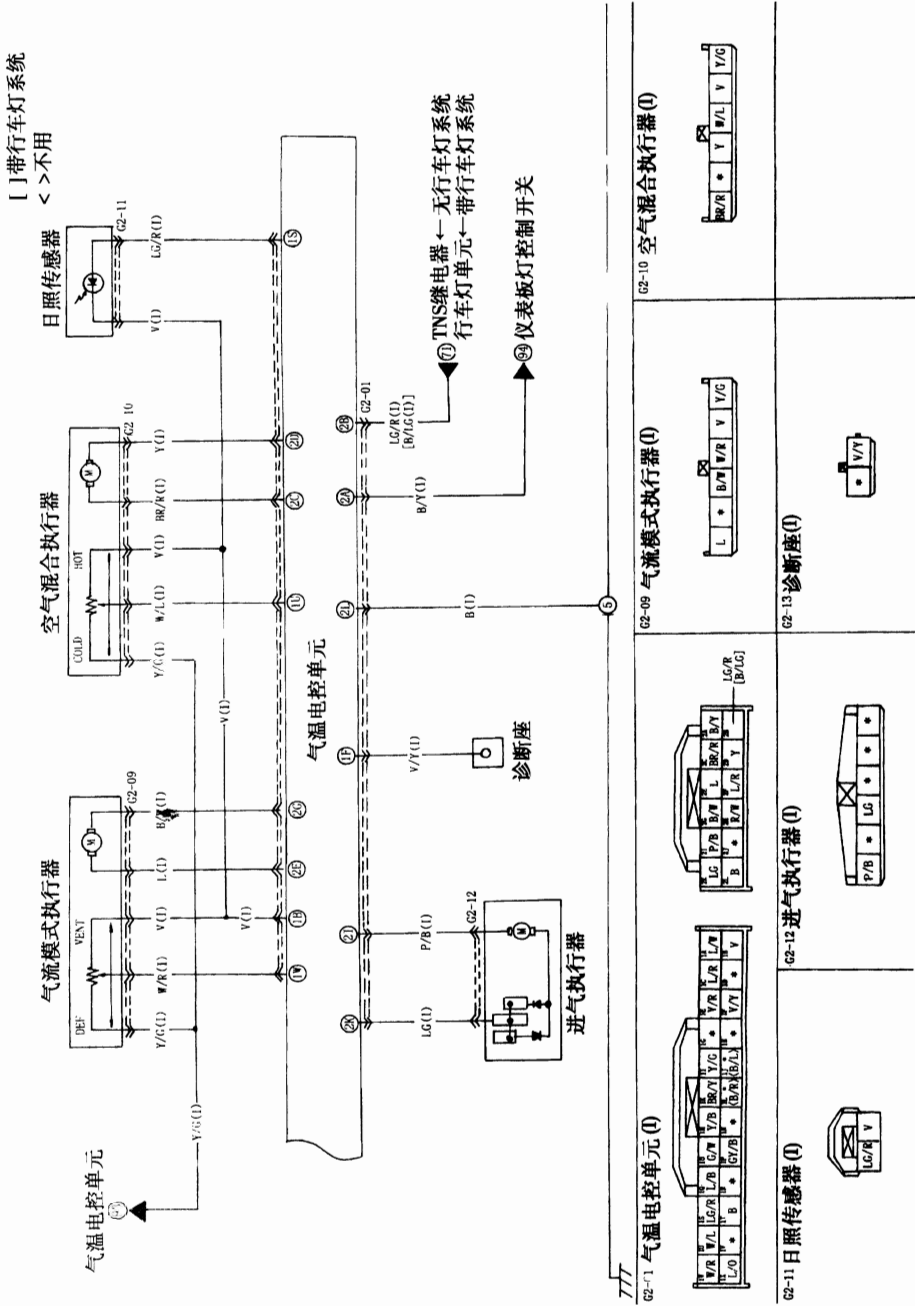
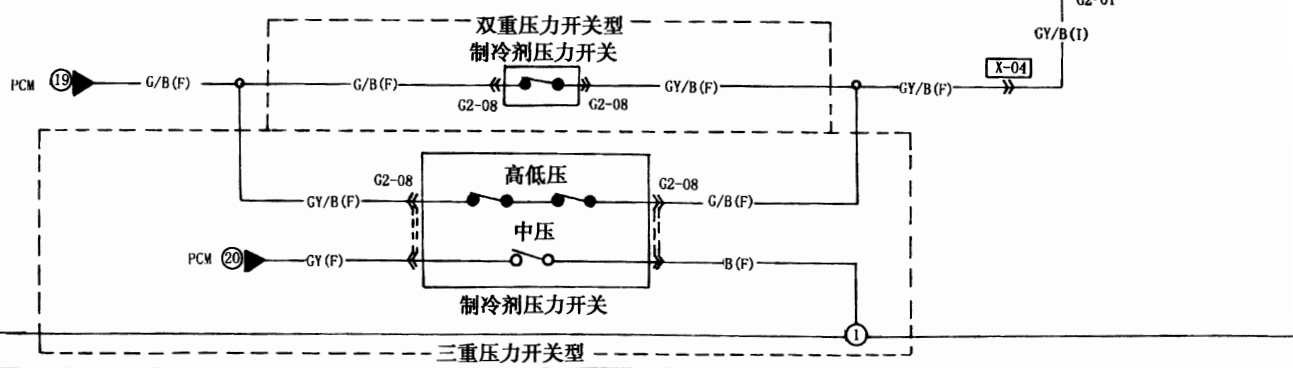
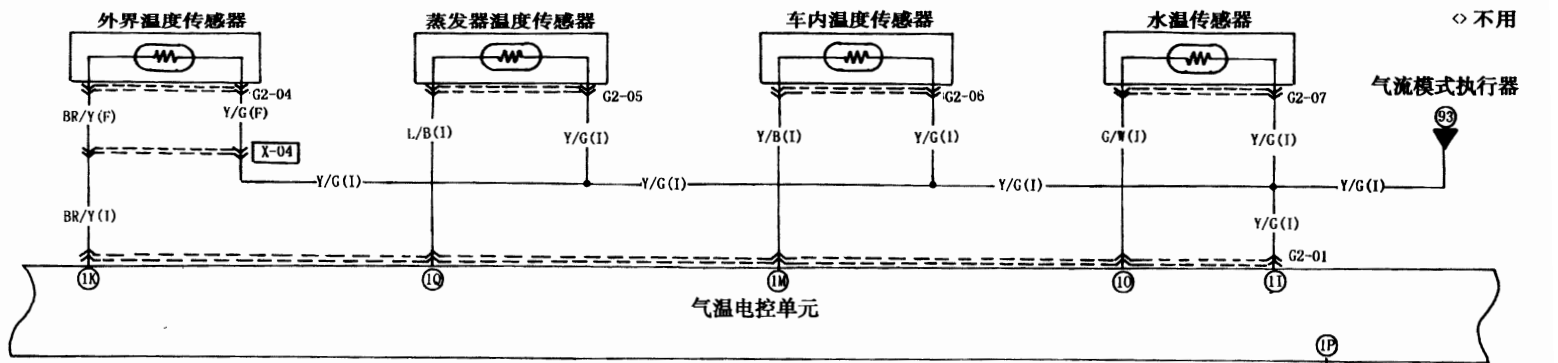
G2-04 外界温度传感器 (F)



G2-05 蒸发器温度传感器 (I)



G2-06 车内温度传感器 (I)



G2-07 水温传感器 (I)



G2-08 制冷剂压力开关 (F)



(双重压力开关型)

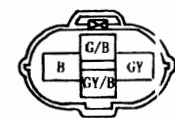

(三重压力开关型)

图 7-3-2 自动空调系统电路图②



图 7-3-3 自动空调系统电路图③



▷带座椅加热
■欧洲规格

点火开关

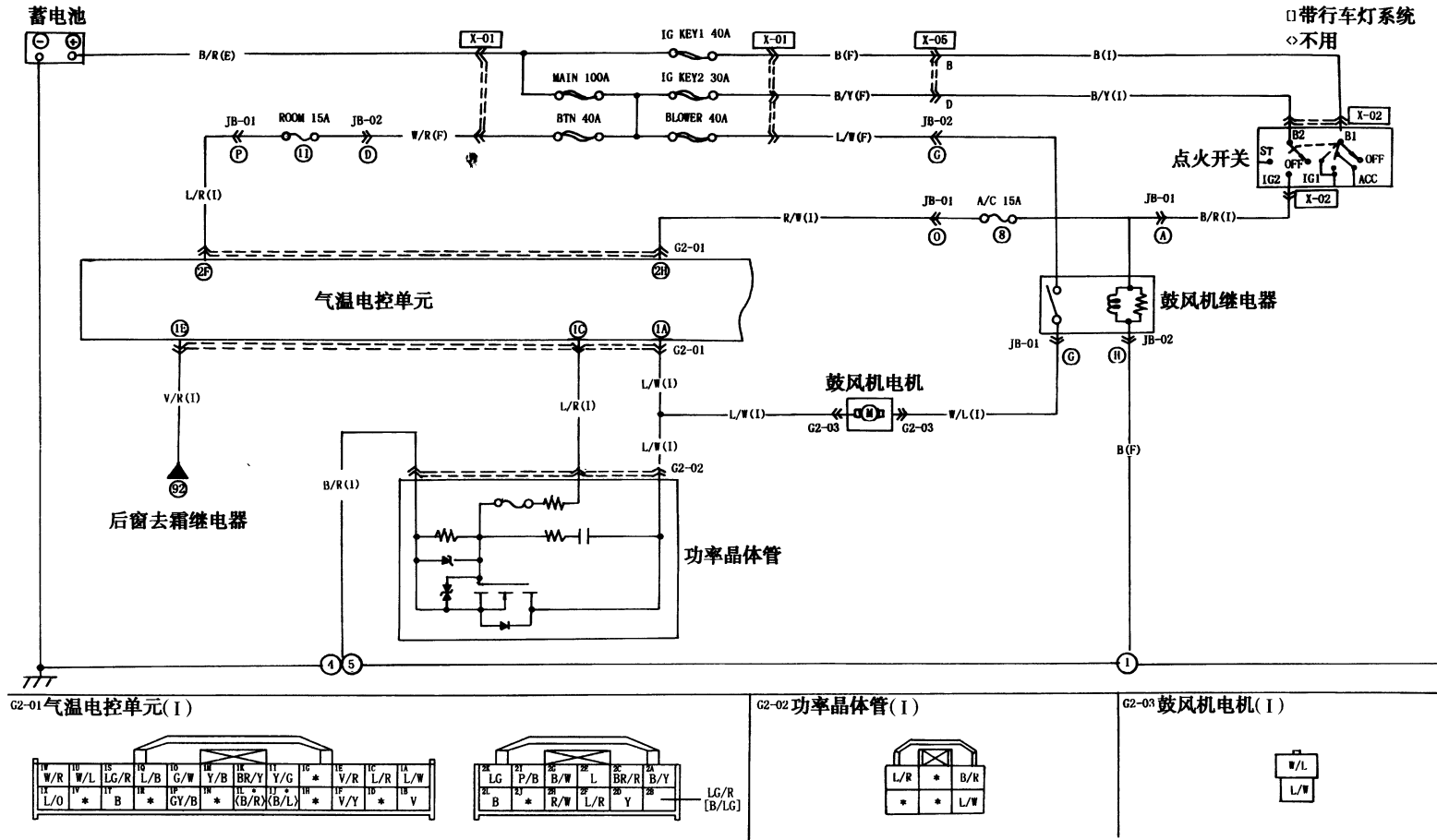
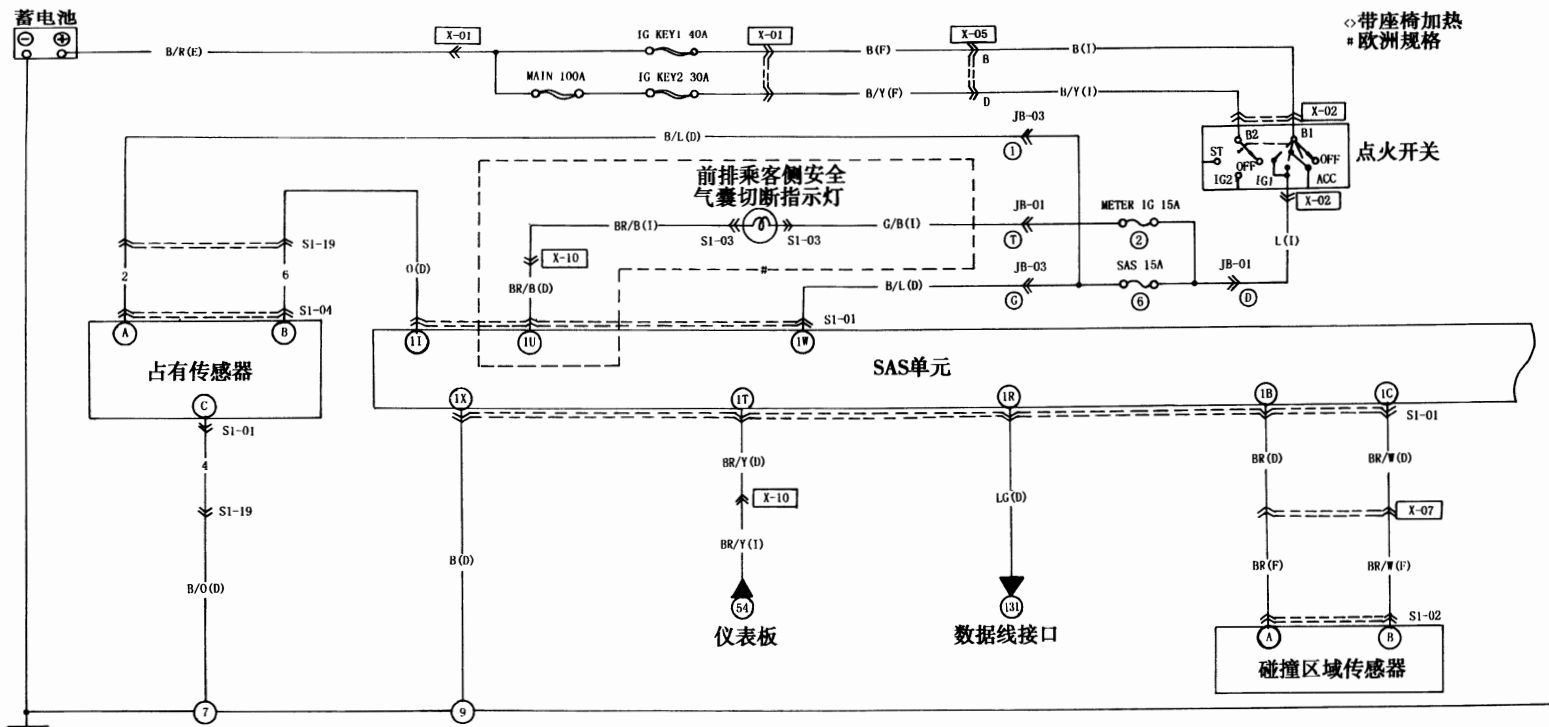
前排乘客侧安全气囊切断指示灯

占有传感器

SAS单元

仪表板

数据线接口

碰撞区域传感器

S1-01 SAS单元 (D)

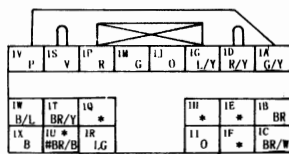

S1-02 碰撞区域传感器 (F)

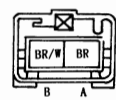

S1-03 前排乘客侧安全气囊切断指示灯 (I)

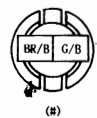

S1-19 仪表板 (D) - 短线

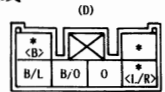

(短线)

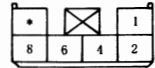

S1-04 占有传感器 (短线)



图 7-3-4 安全气囊系统电路图①



图 7-3-5 安全气囊系统电路图②

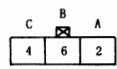

777

SI-01 SAS单元 (D)

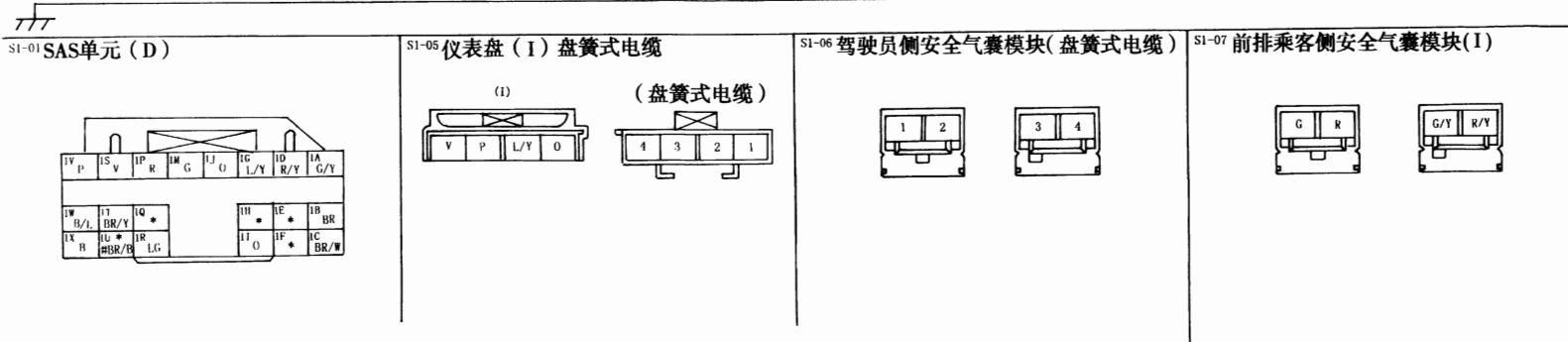
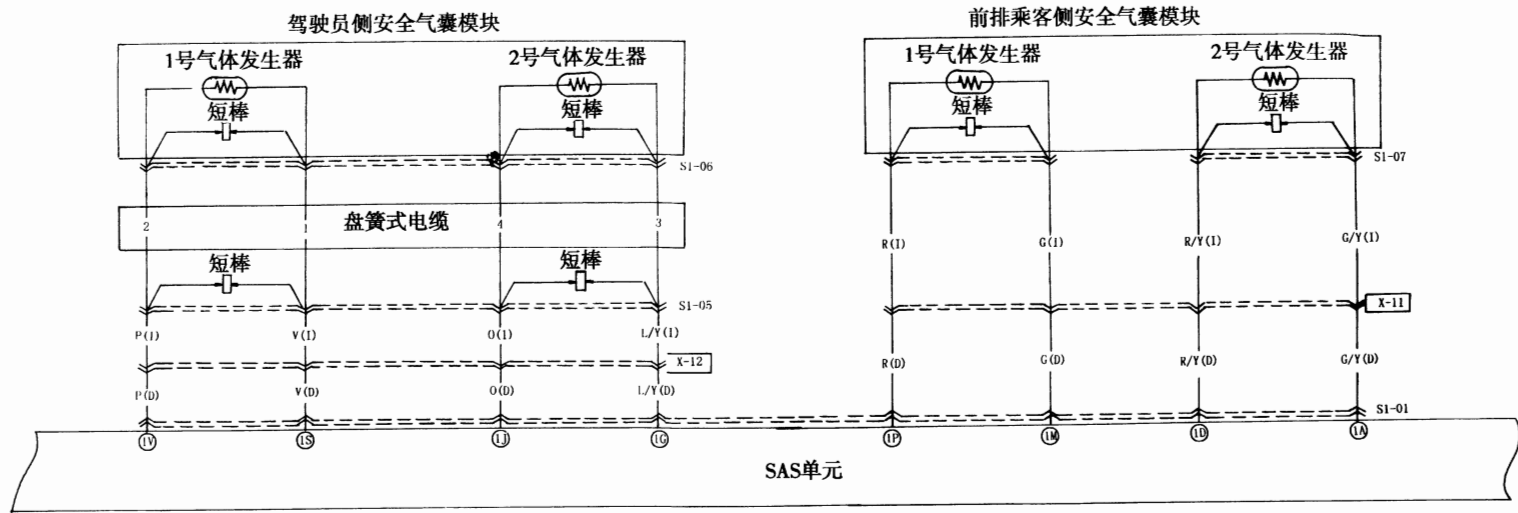
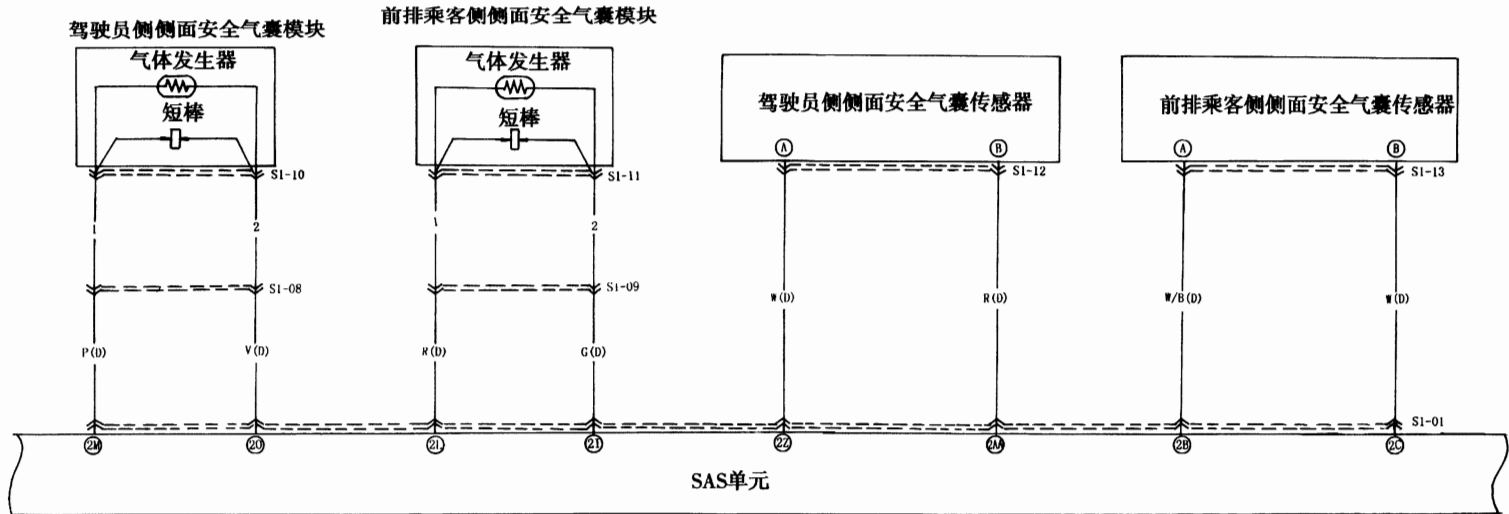
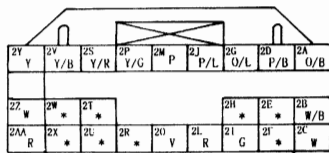

SI-08 仪表板 (D) - 短线



SI-10 驾驶员侧侧面安全气囊模块 (短线)



SI-11 前排乘客侧侧面安全气囊模块 (短线)



SI-09 仪表板 (D) - 短线



SI-12 驾驶员侧侧面安全气囊传感器 (D)

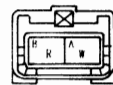

SI-13 前排乘客侧侧面安全气囊传感器 (D)



图 7-3-6 安全气囊系统电路图③



777

S1-01 SAS单元 (D)

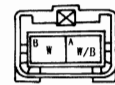
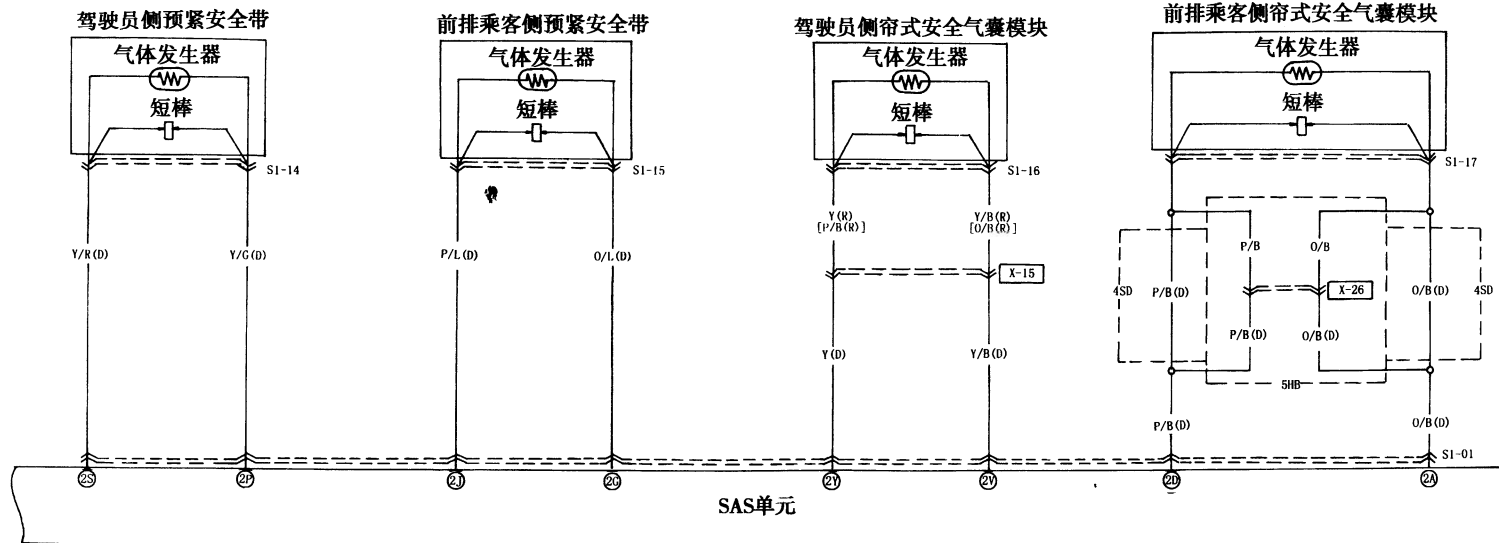
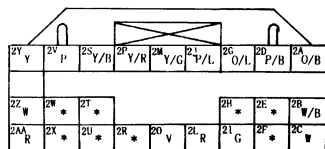

S1-14 驾驶员侧预紧安全带 (D)



S1-15 前排乘客侧预紧安全带 (D)



S1-16 驾驶员侧帘式安全气囊模块 (R)



S1-17 前排乘客侧帘式安全气囊模块

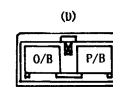

(4SD)

短线



(5HB)

图 7-3-7 安全气囊系统电路图④



图 7-3-8 防盗系统电路图



Q-01 巡航执行器 (短线)

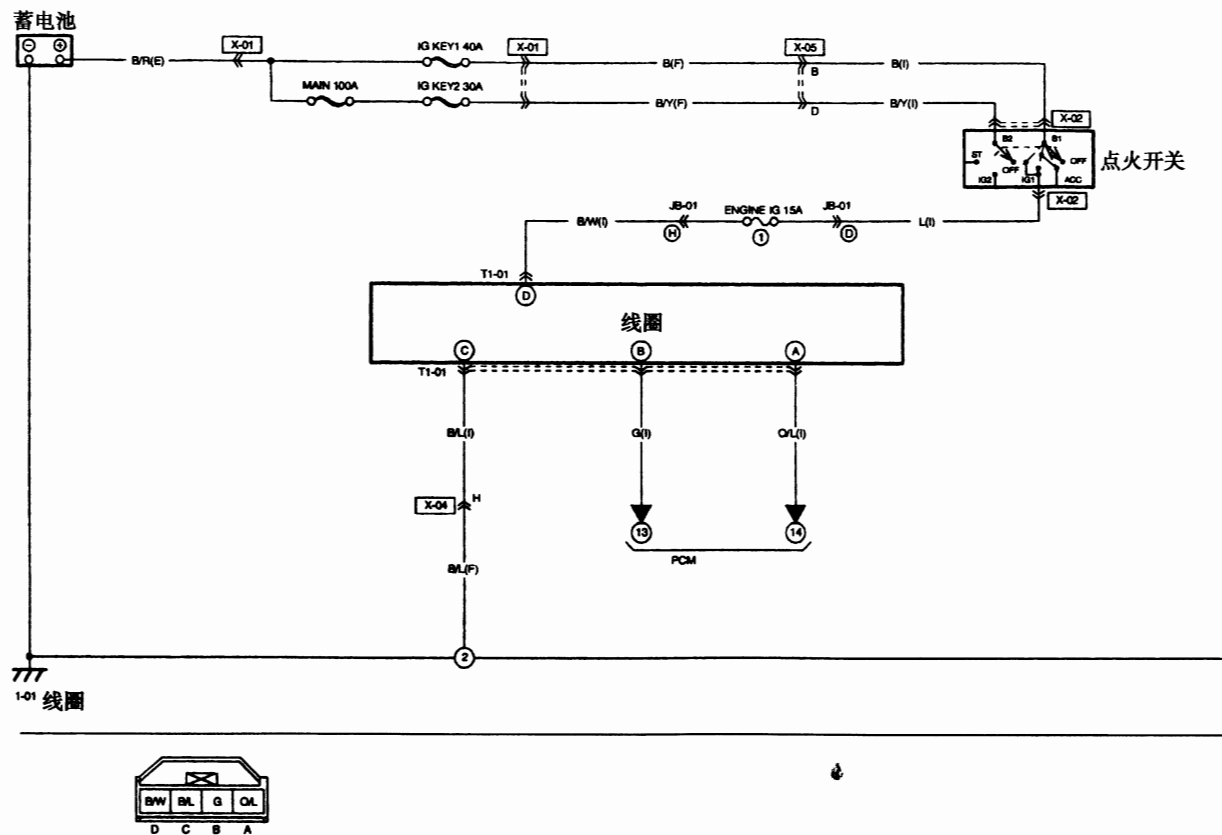
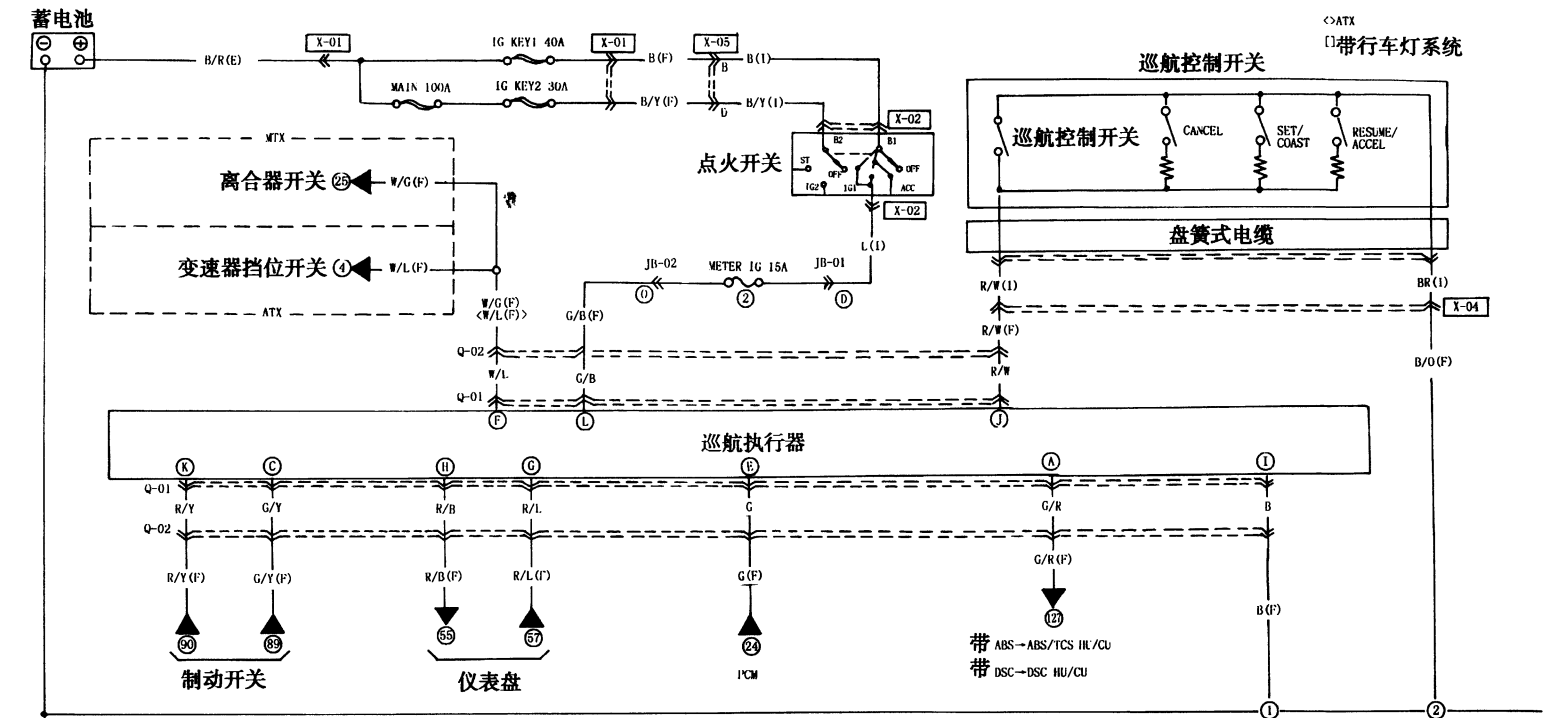
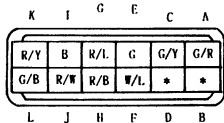

Q-02 前 (F) -短线

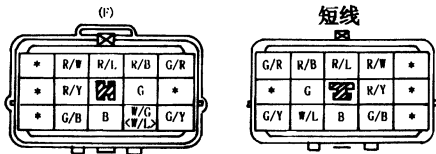

F3-02 巡航控制开关 (I)



图 7-3-9 巡航控制系统电路图

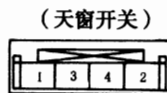
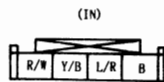
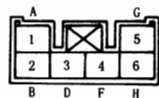
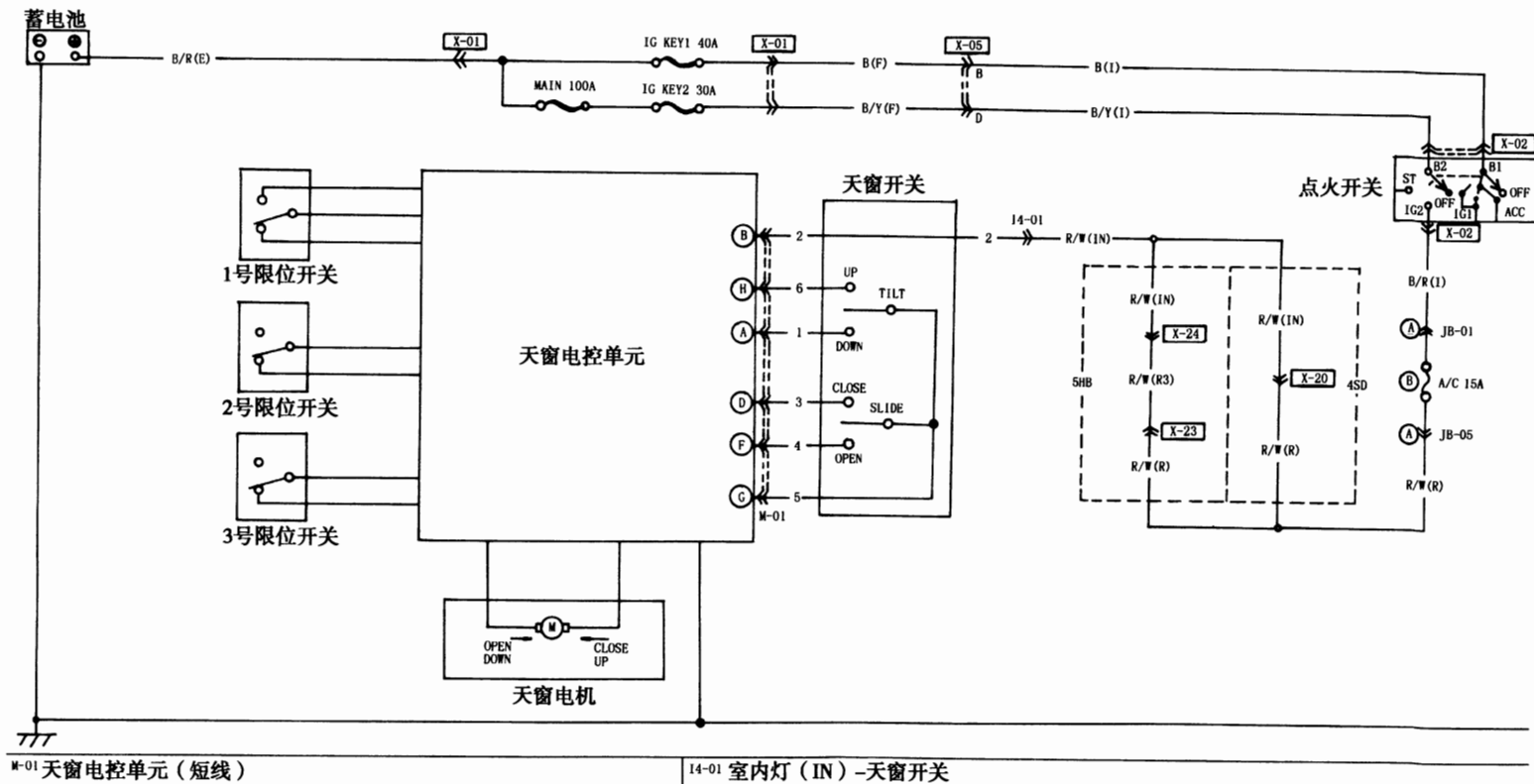

图 7-3-10 天窗电路图